

How To Install PE Pipes

By Poly Pete



Index

	Page
Introduction	1
How I Transport, Store & Handle Pipe	2
How Do I Prevent Damage to Pipe	5
How I Prevent U.V. Damage	6
Temperature Re-rating	7
The Trench	9
Marking & Cutting	10
Electrofusion (EF) Jointing	11
Coloured Pipe Skins	15
Butt Fusion Jointing	16
Curved Trenches	22
Detector Tape (Tracer Wires)	23
Thrust Blocks	24
Backfilling & Compaction	25
Testing	26

Introduction

Hi



All my friends call me Poly Pete, cos I have been installing PE pipes since I was a wee fella. I've laid enough poly pipe to go around the world twice! Maybe I could have stretched the truth a little but PE pipes stretch if you pull 'em too hard!

They asked me to write a booklet on how to install PE pipes. I'll draw some sketches as I go and I'll use illustrations of coiled pipe and

straight ones too! I'll tell a few yarns along the way as I have a few to tell you.

I have worked in rural blocks as well as in town. When you work in town make sure you know your Local Body / Council specifications, I can't detail them as they vary throughout the country.

In the rural blocks I take the **FFP** approach...that's short for "**Fit For Purpose**", I'll refer to **FFP** often in this booklet.

Follow these steps, and you will:

- Do the job faster,
- Do it right first time,
- Avoid those costly mistakes!

I know I can call on the guys at Iplex Pipelines – they'll answer any problems that might stump you. Don't you be afraid to phone Iplex. They have a call free number.

Call them on **0800 800 262** and ask for the Iplex Technical Support Team.

I hope this helps you,

Poly Pete

How I Transport, Store & Handle

You know – you’ve got to look after PE pipes. Although PE is tough it is pretty damn soft and can scratch ‘n’ notch easily if you don’t handle them with care. Don’t let ‘em roll around on the truck deck, tie ‘em down. If ya don’t they’ll get damaged, little stones can get embedded into the pipe from rolling around and can prevent mechanical or fusion joints from working properly, later.

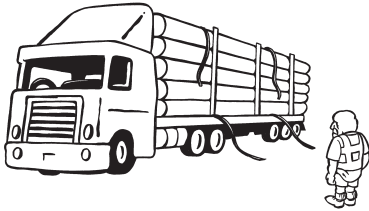

Check the pipe when you get ‘em on site. Unload carefully. **Never** tip ‘em off. When ya unstrap the load keep **way back** from it cos PE Pipe is as slippery **as an old eel!**

Me mate got caught under a loose load once, he was watching a load of big long PE pipes bein’ unloaded, the pipes slipped off the truck and onto him when the load was unstrapped. He was injured...badly.

It’s safer if I can lift them off with my digger or crane using a spreader beam. For really big pipes a rubber tyred four wheel drive telescopic forklift is best. **Stay way, way back** from the load though!!! It’s safer and I prevent damage cos I have more control of the load. For safety’s sake only **one** bundle or pipe at a time! Use nylon straps around the pipes.

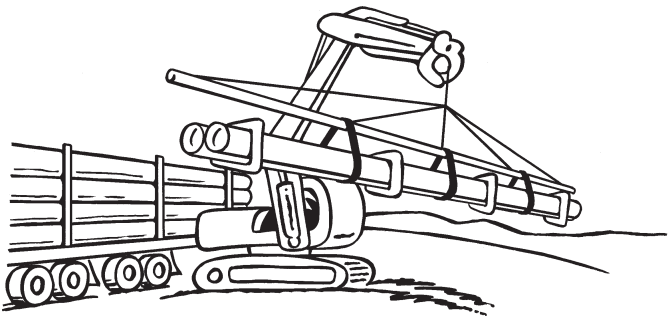

But...if you've got lots 'n' lots of pipe to unload, spend the money and hire a rubber tyred 4x4 telescopic fork lift like this one...

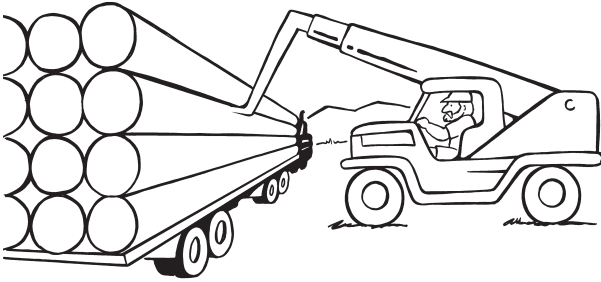

They're quicker and safer to use...you'll cut your unloading time down big time!!!

If I buy my pipes from Iplex they arrive in crates....they're easier to stack 'n' store and much safer too! I always store on flat ground until the trench is dug or you are ready to join em!

For safety's sake... stay way back from the stock pile, they could fall on ya at anytime. Remember they're as slippery as an eel.

Now, small lengths of coiled PE pipe are fairly easy to handle, when you have real long lengths on the job they aren't as easy cos when you cut the straps the stuff gets tangled up!

I use a pipe dispensing trailer, it has a spinning turn-table on it, all ya need to do is place the coil on the trailer, cut the straps and you can walk the pipe off the trailer and into your trench...these make it real easy!

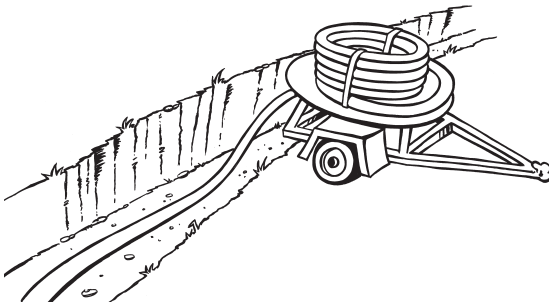

I've done a bit of pipe bursting in my time too, that's one of those in-line replacement trenchless technology methods where you have an ol' water main that you want to rehabilitate without using 'dig n lay' methods. I get Iplex to make coils of 125mm PE pipe and get it made straight onto braked carousels like this.....

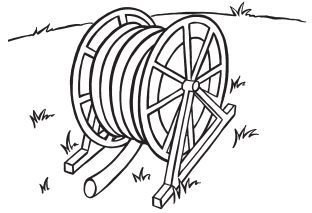

There can be a lot of stored energy in coiled PE pipe. Make sure the pipe-end is strapped down tight and the brake is on securely! Here's another way to do it... 125mm PE pipe made into coils then placed onto a pipe dispensing trailer.

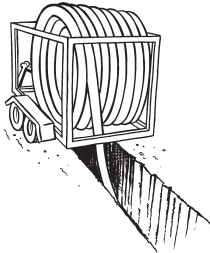

Then you park the pipe-coil over your insertion pit to begin the pull-back.

But... most coiled pipe retains memory of the coil once installed so when you try and connect two coiled pipe lengths together you get this happening.....



So...here is what I do to fix it!



You'll need to use a re-rounding tool before you fuse it together...the re-rounder also acts as a pipe alignment clamp too!



How do I prevent damage to pipe?

I mentioned earlier that PE pipe can 'notch n scratch easily'... that's cos PE is a soft material a lot like wax actually! On a positive note; because of that, it is extremely ductile making a very robust pipe material.

Recently, I was called to a project where a contractor fused up a few hundred metres of 280mm pipe – a long way away from the trench. The fusion guys did a good job in getting the pipe-string fused together – damage free. Later, another contractor came along and dragged the pipe-string to the trench without any protection, rollers or wheel sets.

They dragged the pipe-string over farm paddocks and a gravel track, then up over a wire fence. By the time it got to site it had a gouge from one end of the string to the other! When we measured it the depth of the gouge was less than 10% of the pipe wall thickness – so...reluctantly the asset owner approved the installation. I always aim for **no damage** once installed – **you should too!** Use proper pipe rollers or wheel sets to transport pipe-strings to the trench, here's how I do it.....

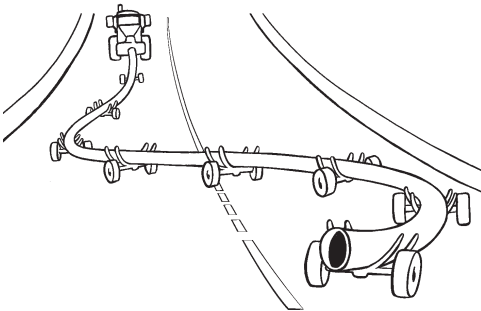

A lot of pipe is now made with coloured skins – usually on a black base. Blue is for water, yellow for gas, cream for pressure sewer, etc. The skin is there to help identify the pipe, not to provide extra damage protection or an easy way of telling the depth of any surface scratches. If you have pipe with the base colour showing through a scratch on the skin it might be still OK to use. Always measure the depth accurately using a proper tool before rejecting the pipe!

How I Prevent U.V. Damage

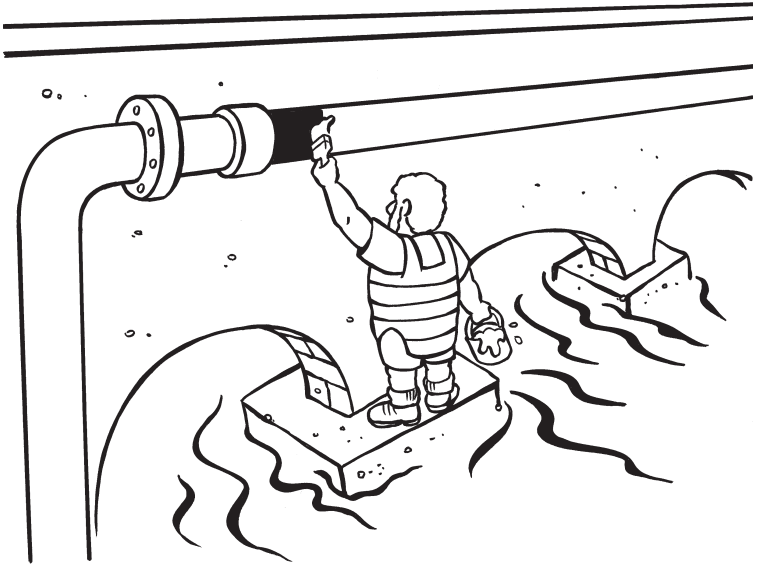

Hey, black pipes are the best to use outdoors cos black reflects the ultra violet rays better. U.V. attacks coloured PE pipe real quick! If you need to use striped or colour skin pipe for some reason, paint 'em with a light coloured acrylic paint... The light colour paint will reflect the heat in those hot summer months.

But some UV exposure is OK... as I said use black PE pipe, avoid coloured PE pipe where possible.

Vegetation growth can provide enough shelter from the U.V rays particularly when pipe is laid above ground in a forest.

Pipes installed above ground should be laid slightly snaked to allow for expansion and contraction.



Temperature Re-rating

All PE systems operating above 20°C require temperature re-rating. If you've seen this type of



pipe rupture before, you need to know what causes it. This is a typical ductile failure mode caused by the internal pressure exceeding the pipe's capability, a number of factors can cause it, including:

- High pump pressure
- High static head
- Or, elevated temperatures

In elevated temperatures an example could be that on a 25°C day, the external temperature of a black PE installed in direct sunlight may be greater than 50°C, lowering its long-term expected life and the pipe's maximum pressure capability – basically the pipe bursts because it becomes “hot ‘n soft”, the internal pressure creates a ductile pressure burst. This type of burst is called a “parrot beak failure” cos it can look like the underside of a parrot's beak. In these installations you must apply a Temperature Re-rating Factor or TRF to allow for the loss of pressure that the pipeline reduces by when it gets too hot. On the next page is a table showing the Temperature Re-rating Factors at a range of temperatures.

Step 1

You need to determine:

- If your pipe is LDPE, PE80 or PE100
This is the grade of the pipe, it relates to its material-strength. It should be written on the pipe.
- What the peak pipe temperature might be during hot summer days.
Usually measured from another pipe exposed to the sun nearby.

Step 2

Select the TRF from the chart on page 8.

Step 3

Now, get your calculator out....and recalculate your pipes new pressure rating. Here's two examples that show you;

Example 1: We'll assume your pipe is PE100 and rated to PN8 pressure. You've already determined that other pipes installed nearby have a peak wall temperature of 45°C – during peak hot summer days.

Therefore, off the PE100 chart ... TRF = 0.76

Equation: $8 \times 0.76 = 6.08$.

Therefore, the new calculated pressure rating for a pipe exposed to the sun during summer with a pipe-wall-temperature measured at 45°C is to be re-rated to PN6 (rounded down).

Example 2: Let's use the same conditions.... but now you'd like to determine what pressure class is needed to achieve PN8 pressure rating, here's how you calculate that:

Equation: $8 \div 0.76 = 10.5$.

Therefore you require a pipe that will take a minimum of 10.5 bar, Iplex has a PE pipe rated to a pressure rating of up to PN12.5 – you'll need to install this pipe to deal with the increased temperature during hot summer days.

Temperature Re-rating Factor Table

Temperature (Degrees Celsius)	Material		
	LDPE	PE80B	PE100
20°	1.0	1.0	1.0
25°	0.87	1.0	0.9
30°	0.79	0.83	0.9
35°	*0.71	0.76	0.83
40°	*0.63	0.76	0.83
45°	*0.55	*0.71	*0.76
50°		*0.62	*0.71
55°		*0.58	*0.71

***If your pipeline is operating in the red zone**, service life will be reduced. I highly suggest you obtain professional advice from a design engineer or **call the tech team at Iplex**.... they'll ask a bunch of questions and provide you with an accurate recommendation.

The Trench

Me other ol' mate Pipeline Percy wrote one of these booklets on PVC pipe, the in trench rules are exactly the same. If you're in town the engineer's plans always tell me how deep the trench should be. The width is important too, for both PE and PVC pipe it should not be more than 300mm wider than the pipe size at the top of the pipe, if heavy traffic is to pass over it. For example; 160mm Pipe – trench width should be 460mm. Above the crown of the pipe any width will do.

I always throw in a bed of compactible gravel, sand or fine scoria for the pipe bedding and surround.

My mate Winnie helps me to get the pipe into the trench.

I **NEVER** drop 'em in!

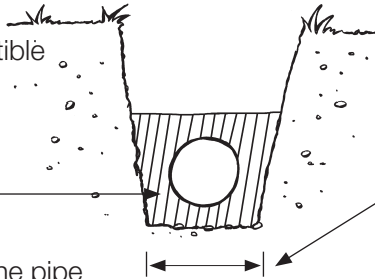

Pipe size – plus 300mm (This saves backfill material as well!)

When these PE pipes get real big 'n' long...you won't be lifting 'em cos they are too heavy...you'll need a real big digger for real big and long pipe-strings!

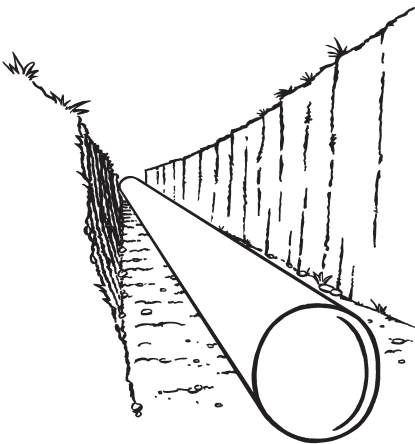

When ya' in the rural blocks take the **FFP** approach... but use your common sense... big boulders and organic material (lumps of turf) don't work as bedding, get 'em out. Use loose selected as dug material in the backfill zones, remove the big boulders as they could damage any plastic pipe!

Marking & Cutting

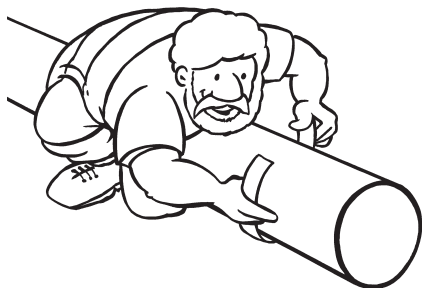

Marking PE pipe is not easy cos the pipes are usually black. For black ones you may be forced to use a piece of

strapping to wrap around the pipe then mark off using a piece of Kiwi ingenuity...a piece of number 8 fencing wire! A white crayon will work fine too.

I always cut small pipe using a fine-tooth hand saw. It's much easier if blocks of wood are under each pipe. You can use a guillotine too.

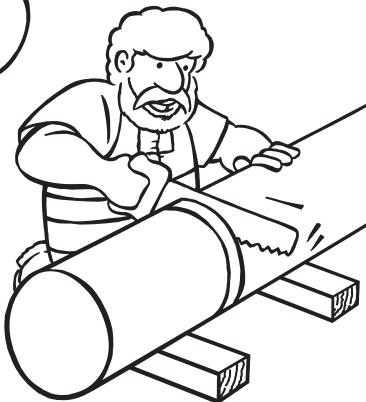

An electric chainsaw is OK too but if you plan on any **HOT** fusion jointing then you should never use a chainsaw with the chain oil function operating cos the oil stuffs up ya' fusion (welded) joint. You are better off replacing the saw's blade and chain more often than have a whole heap of failed fusion joints on a job somewhere!



Electrofusion (EF) Jointing

Once you know how to complete EF jointing its easy. But... you need a bit of training first. I highly recommend that you sit a training course to learn how to fuse PE pipe correctly.

Go to www.nzweta.org.nz to register for a class.

You need a whole bunch of tools and equipment. Most guys buy an EF machine, hand scraper, and think they are in business. Well...guess what?...they aren't. You need to spend as much money on other special tools as you've just spent on the fusion machine itself. Here I'll show you what you need!

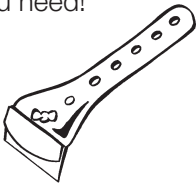

Hand scraper

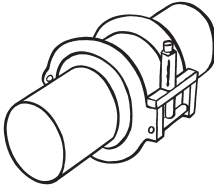

Re-rounding tool

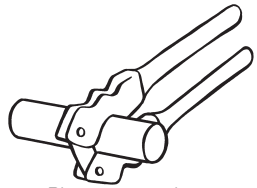

Pipe support clamps

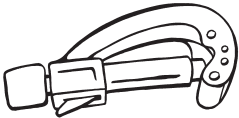

Rotary cutting tool

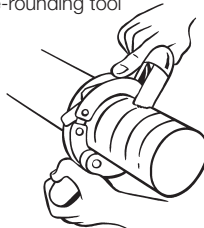

Rotary scraper



Guillotine

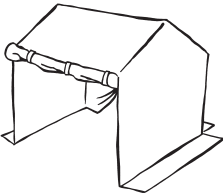

Utility work tent

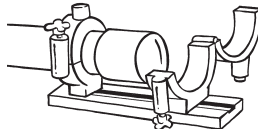

Pipe alignment clamp

Some of these tools are needed for each diameter of pipe that you wanna join! Without 'em the job **WON'T** and **CAN'T** be done right!

Before you start make sure the EF couplers/fittings are compatible – you can't use a SDR26 fitting to join SDR9 pipe!

I usually hire a 5kva generator too. Hey... another yarn...

Me mate Bob was fusing some EF couplers into a 300mm trunk main once, the genny run out of gas during the fusion

process! He had to cut out the joint cos the fusion machine didn't complete the full fusion cycle. So, before you start make sure that the genny has plenty of gas! What I do is I treat it like my belly... I start the day with full tank (or belly), then when I need food I fuel up genny too! Easy!

With any fusion welding I always take this approach – **“If in doubt cut it out”!!** I highly recommend that you adopt this too!

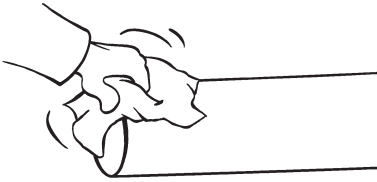

Step 1

Clean your pipe...and yourself including the cuffs on your overalls... 'cos whatever is on you will wind up on the pipe somewhere. If it is sunny and you've

used sun screen then remove it! Make sure the pipe is dry, free of dirt and **clean, clean, clean!!** You should always join pipe under cover, a tent works best or a large umbrella can do the job **sometimes**. The cover keeps the wet, windy 'n' hot weather off your work. If you don't use cover you're taking a shortcut and you shouldn't be doin' that! Check your equipment to make sure it is workin'; and when your're in a trench make sure you have a minimum of 150mm all around the pipe.

Step 2

Cut the pipe square – **the ends must be square**. Guillotines are best.

Remove the burrs if you've used a saw. Wipe the pipe inside 'n' out with a big towel first, then wipe the pipe using a handful of alcohol wipes (not just one). This cleans the pipe thoroughly! Remember the pipe must be dry and **clean, clean, clean!!**

If you have lots of joints to do I suggest you buy a big container of



alcohol (IPA) fluid and a bag of **new** lint free 100% cotton “Terry Towels”. Avoid using those rag bags from your local supply shop cos you don't know where they have been – they could be contaminated. I find that 400mm x 400mm ‘Terry Towels’

work best. Make sure you dispose of all dirty 'Terry Towels' immediately. They make good polishing rags for your trucks once used!

I've seen some guys use black felt pens on blue pipe and white silicone pens on black pipe to draw on the spigot to act as an indicator before peeling begins. Their theory is when the ink has disappeared from peeling the joint is ready to fuse. But a few blokes in white coats (scientists) once proved that the white pens can leave traces of silicone behind causing failed fusion joints. To avoid that happening to you I suggest you don't use them at all!

You can use a hand scraper... I avoid them though. If you have a professional and responsible approach to contracting then don't be tight. Do what all good tradesmen do – spend the money and buy the proper tools. Rotary scrapers are designed to control even peeling of the oxidized layers on the pipe. They do the job properly by peeling off all dirt, oil and the U.V. attacked layers off. Follow the peeling tool manufacturer's operating instructions.

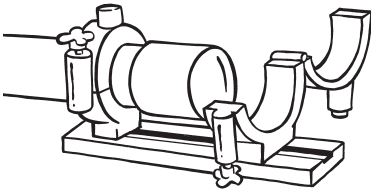

Step 3

Make sure the area to be fused is moisture free. If you have fittings that have been out of their plastic bags don't use 'em... I always open

one end of the plastic bag. Slide the fitting on keeping it in the plastic bag. Never touch the inside windings of the EF fitting as the residue from your hands can contaminate the fusion joint.

Now, when you are installing slip couplers you need to peel right back, approx 2.5 times the coupling's length cos the slip coupler needs to be pushed past the end of the first pipe spigot. Once the second spigot is peeled and in position slide the coupler back onto the other spigot. Make sure you have the centre of the coupler bang on the two spigots. Inscribe a **witness mark** on the pipe spigots to the correct finished position before you begin!

In most cases the PE pipe will be out of round and your EF coupler won't go on. This is when the re-rounding tool works for you.

Coiled pipe will always be out of round!

Using another special tool that you bought... the pipe support clamp. Some double up as a re-rounding tool. Then fit the other pipe into the fitting and tighten the pipe support clamps. It'll hold the joint firmly while your fusion joint is being completed.

Step 4

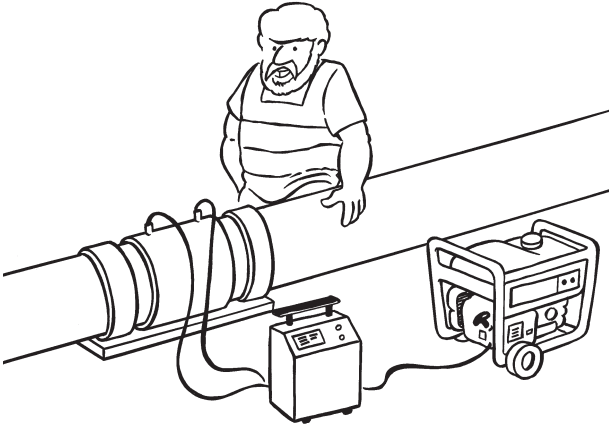

You'll need a good power source. If you don't have one fire up your genny...Remember... check the gas tank, make sure it's full and ensure all the cords that you plan to use are in good health. The EF control unit should be checked to see that it is compatible with the fittings that you plan to fuse. Connect the cables to your fitting and begin the fusion process.

Some fittings have one of those ol' 'Tegel Timers' on them. The little titty pops up when the fusion cycle has been completed. But, they are not an indicator that tells you if you have good joint or not. All it tells you is that electricity has been through it. If they don't pop up then there is a good chance that you may not have a good fusion joint. You should **never** reheat a fitting twice! Remember... **if in doubt cut it out...** and start again. I know it is tough but that's how it should be!

Make sure the fusion cycle has been completed and then... the cool time begins. Check on the fitting – the cool time should be written on it somewhere. **Do not** move the pipe **at all** until the cool time has passed.

Step 5

This is when you need to take a look at the joint and **make a go or no go call!** If there is any sign of misalignment or PE material oozing between the pipe and the fitting then apply our **if in doubt policy!**

Step 6

Only then should you unclamp your pipe support clamps and move onto your next fusion joint.

Step 1-6: You **can't** do any fusion jointing while compaction equipment or other machinery is **working in your trench**, until the cooling phase has been completed.

Coloured Pipe Skins

I mentioned on page 6... *“A lot of pipe is now made with coloured skins – usually on a black base. Blue is for water, yellow for gas, cream for pressure sewer etc”.*

When preparing your pipe for fusion jointing, don't try and peel all the skin off, just use your normal scraping or peeling process.

The skin is the same material as the base. They're extruded together creating a single solid wall section.

Butt Fusion Jointing

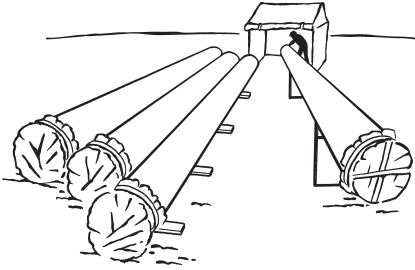

Butt Fusion jointing requires a high level of care and attention ... you need **a lot** of skill and training! Although some guys try to train themselves you shouldn't. I highly recommend that you sit a qualified training

course to learn how to fuse PE pipe correctly. Go to www.nzweta.org.nz for more information.

Before you arrive on site you need to do a bit of planning. Take a look at the site and decide where a flat staging platform can be created. I work with this policy...

- Fusion Platform - pipe length x 3 x 4m wide
- Pipe String Platform – proposed pipe string length x 5m or wider.

Ya' need a bit of space for pipe storage too! Make sure the storage space is close to the fusion platform. Above is a picture of one of my recent 500mm pipe jobs. Do you like my bagged pipe ends? Always bag 'em cos it keeps the breeze out and stops the dragonflies flying up the pipe. It happened to me once during a shift cycle – he got fried in the pipe joint!

Here is my typical pipe string staging area...

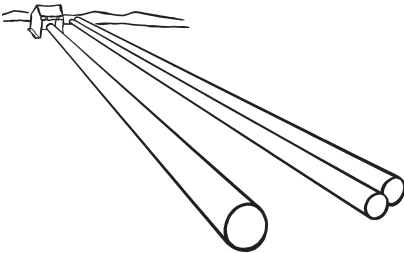

Remember what I said earlier, those big PE pipes are heavy so I use a dedicated fork lift. Some guys use a digger but diggers are too slow for me. They can hold up other stuff on site. An off

road rubber tyred 4x4 telescopic fork lift works best. I usually hire a Merlo P26.6 PLT. They are fairly stable and good for pipe up to about 500mm. They are quick to use around the site and manoeuvrable too.

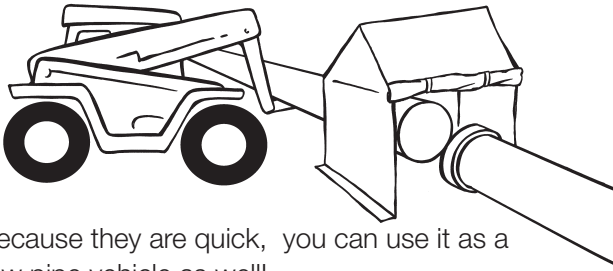

Because they are quick, you can use it as a tow pipe vehicle as well!

Once on site, complete your first fusion joint and send away for tensile testing.

Some asset owners may want you to tensile test fusion joints randomly along the pipeline as well. When you change fusion technicians it's common to present new joints for tensile testing.

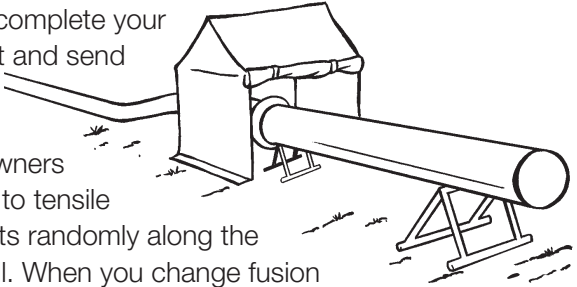

Now follow these important steps:

Step 1

Set up your pipe rollers. I try and have the pipe string being towed out, on rollers as it reduces the drag.

Step 2

Clean heavily caked pipe outside the fusion tent, ensure your pipe is in the rollers sitting level and level in the butt fusion machine inserts or cradle too.

Step 3

Place your next pipe onto level rollers. This reduces excessive drag on your fusion machine and joint.

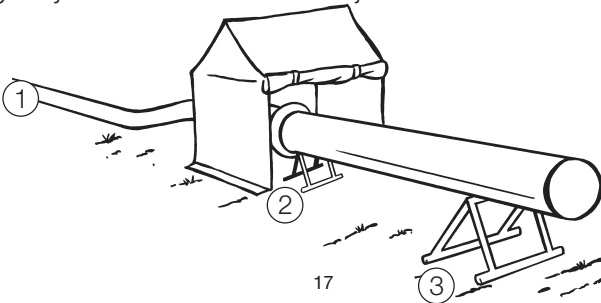

Step 4

Clamp up and align your pipe ends to ensure the two pipe spigots are evenly aligned around the entire circumference of the pipe. Most machines have adjustable jaws to correct out of round pipe.

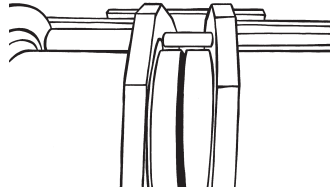

Step 5

Clean the pipe inside, outside and remove any stones that may be embedded into the pipe barrel or spigots. If you don't these could damage your facer blades or facer. It happened recently to some guys new to butt fusion jointing. They

bought a brand new machine and on their first butt fusion joint trial little stones scratched the facer...bugger!

Step 6

Face your pipe, leaving **no gaps** between the two pipe faces, no notches or unfaced pipe ends.

Step 7

Now that you are ready for fusion, clean your heater plate. I use IPA to clean the plate before I begin heating each day. Then, I buff up the heater plate to remove all residue...IPA can leave a film so BUFF IT UP well to remove the white dull film! I use 100% cotton lint free Terry Towels, a 400 x 400 size towel works well.

Once the heater plate has conditioned itself I manually check the temperature using a calibrated Pyrometer at a number of positions around the heater plate where the pipe will make contact.

Step 8

Remove all dust from the pipe ends with a 'Terry Towel' and place your heater plate between the pipe ends and follow your fusion jointing procedure completing the fusion joint.

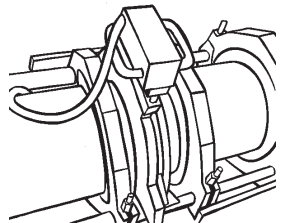

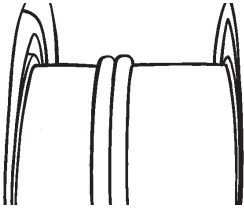

Step 9

Wait for the cooling time to pass. Then inspect the joint for consistency. The fusion bead should look like the McDonalds M. Check your data logger recordings, then make a **go or no go call**. Remember...**if in doubt, cut it out!**

Some asset owners like to remove the fusion bead for gravity sewer pipes. Some don't cos the bead can be hard to get out, then the daggs left behind snag sewage causing blockages in the drain. Now is the time to remove it but you **must cut it out** while the bead is still warm. Even then, sometimes they are difficult to get out cleanly. Ya' have one shot to insert the bead removal tool so... get it right. It needs to come out in one piece, like this...

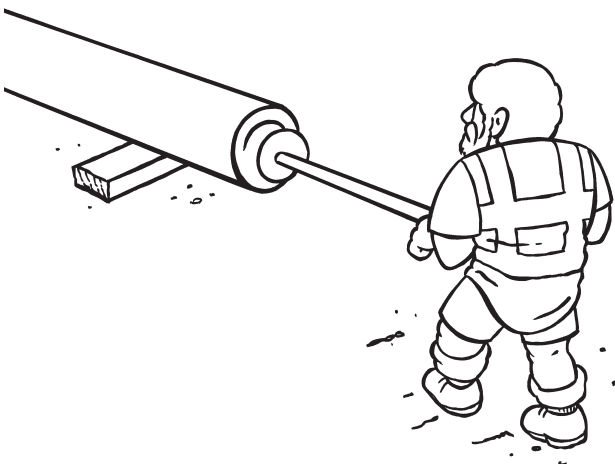
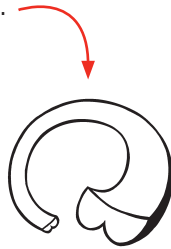

Step 10

Then unclamp the pipe string and raise the rollers.

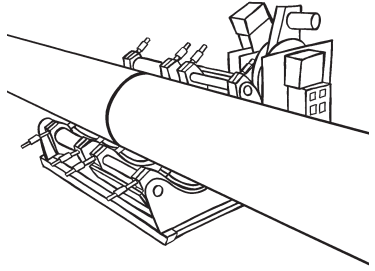

Step 11

Haul out the pipe string through the fusion machine on the rollers and move onto your next fusion joint.

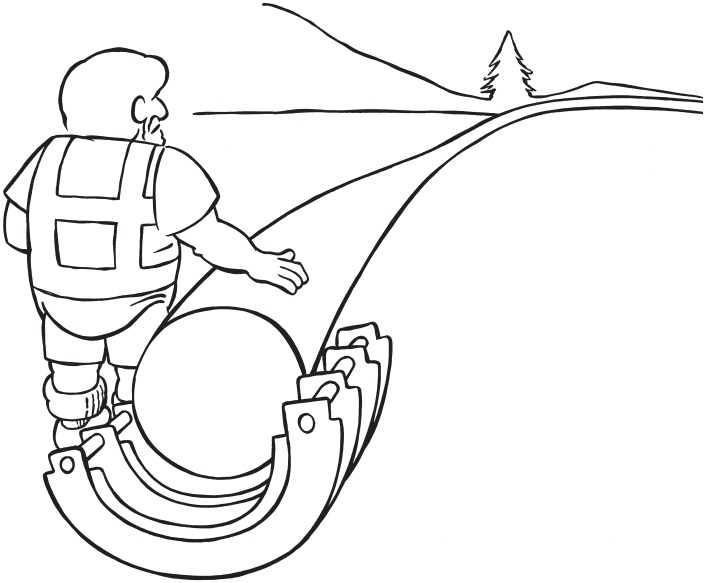

Now, I always get asked, how do you join two pipe strings together when one string is already in the trench? You might be able to use an EF coupler. If you can't, here is what ya' need to do.

The first thing is you need to buy the right fusion machine. You need a BF machine that has removable top jaws facing up in the bed of the frame on a 45° angle helps, like this one.

Then dig a pit where the pipe will join. I work to these pit dimensions:

Width = 4 x BF machine

Length = 2 x BF machine

Depth = 1.3 x pipe diameter...

+ or – a touch!

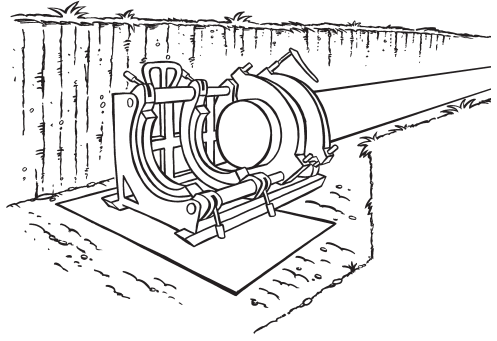

Place a thick large steel plate in the base of your level excavated pit that you are going to be working in...

I bought a wheeled hydraulic pallet jack specifically for pit fusion, lift this into your pit next.

Lift your BF machine in and place it on the pallet jack. Adjust the BF machine to the correct height for fusion and clamp up.

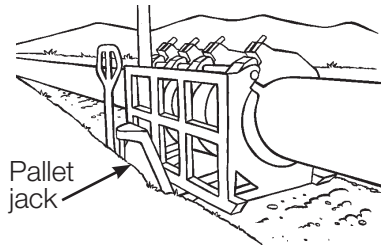

Then bring your next pipe string in on rollers, clamp it up and fuse it!

Once the joint cooling has been completed, unclamp the pipe, remove the upper jaws, drop the pallet truck height down and wheel it out backwards. Don't forget safety comes first... if you are deeper than 1.5m trench shields may be required.

Always use a tent to cover the weld site. A tarp laid out under the fusion machine will stop the dirt 'n dust getting in your joint.

Curved Trenches



Although poly pipe can bend fairly easily there are some limits. I will list below what the allowable radii are –

Minimum Bending Radius (mm)

Standard Dimension Ratio	@ 20°C	at 0°C	by Pressure Class (bar)	
			PE80	PE100
SDR26	25 x DN	60 x DN		PN6.3
SDR21	20 x DN	50 x DN	PN6.3	PN8
SDR 17	20 x DN	50 x DN	PN8	PN10
SDR13.6	20 x DN	50 x DN	PN10	PN12.5
SDR11	20 x DN	50 x DN	PN12.5	PN16
SDR9	20 x DN	50 x DN	PN16	PN20
SDR7.4	20 x DN	50 x DN	PN20	PN25

Detector Tape and Tracer Wires

Those radio detection devices for pipes require an electrical wire to be laid in the trench so they'll work...

sometimes the engineer will want you to lay a wire with the pipe. Detector tape is also used most of the time.

Lay it as instructed by the engineer or no less than 100mm above the pipe.

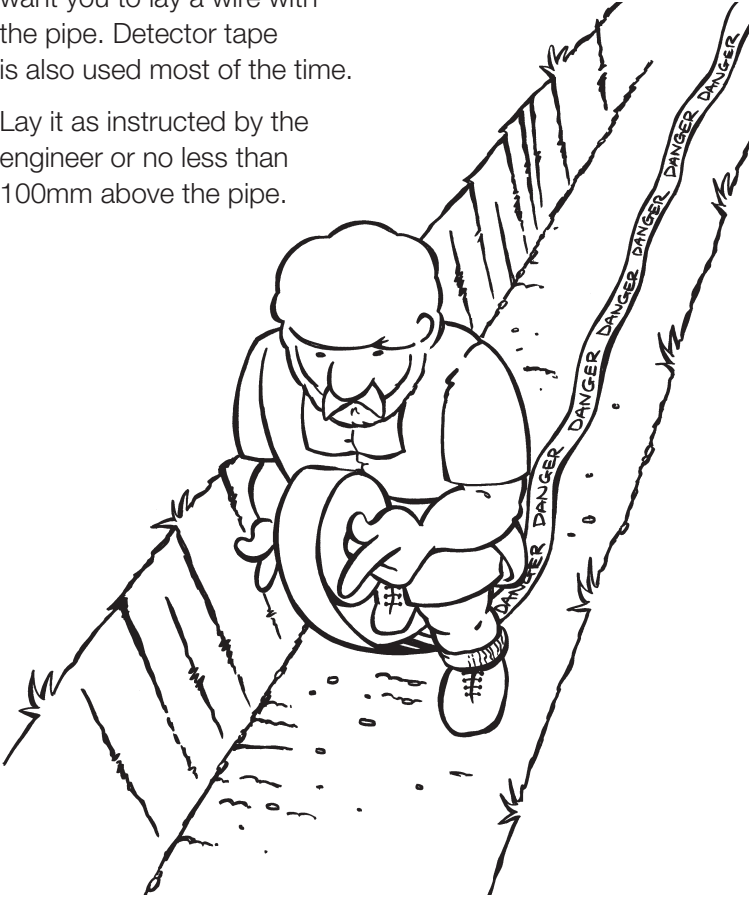

Thrust-Blocks



If thrust-blocks are to be constructed they might be needed at changes of direction for bends and tees, etc! The size of each Anchor block may vary – the engineer usually designs these so talk to him before you build it. It must be poured against freshly dug solid trench walls. I have used timber to make my boxing before, but prefer to use layered sand bags to create my shape as this allows trenching 'n' pipe laying to continue. Thrust-blocks must be in and cured before testing (cement takes 28 days to cure). Then I completely backfill the trench.

Backfilling & Compaction

Use a dazzle spray can to mark
off your compaction layers...
it takes the guessing away
and really works well for deep
trenches

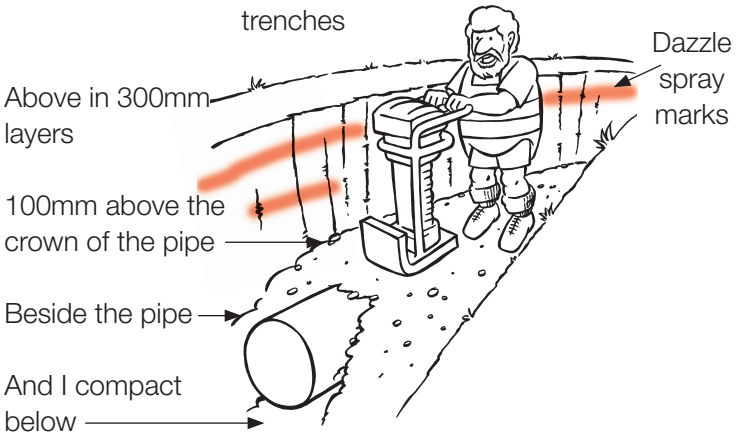

Compacted granular bedding/aggregate surrounds the pipe and up to a minimum 100mm above the pipe. Then I use selected ordinary backfill. I compact with my machine below, beside and above the pipe in layers of 300mm until I get to the top surface.

I backfill with dense solid material like sand mixed sized pea metal or scoria which has no sharp or large stones (over 20mm) in it. I must fill all the gaps and spaces in between the pipe and trench. Once the metal is placed I haunch the bottom of the side support zone by shuffling my shovel along the pipe this shuffles metal under and beneath into the 5 o'clock to 7 o'clock zones.

If I do the compaction correctly I never need to be called back to the job to correct slumped trenches. I never get paid for doing a job twice...any call backs are on me!

I do it once and I do it right...First time...then shout myself a cold beer for doing a good job!

Testing

Pressure test procedures for testing PE pipe are complex. Procedures vary and are dependent upon the pipe diameter, pipeline length and what the pipe is being used for... gravity or as a pressure pipeline.

Check your contract documents to see what the owner wants or **call Iplex 0800 800 262** and ask for them to send you their pressure test guide! All my concrete must fully cured (up to 28 days) before testing.



Well that's it...It's easy when you know how! Always do it right the first time - Keep on diggin...!!

Poly Pete

Disclaimer:

The information, opinions, advice and recommendations contained in this publication are put forward with the main object of providing a better understanding of technical matters associated with pipeline and component design using Iplex Pipelines. Whilst all reasonable care has been made in ensuring that the information contained in this publication is accurate, this publication should not be used as the only source of information by the reader. Reference should also be made to establish textbooks and other published material, and readers should not rely on the information contained in this publication without taking appropriate professional advice for their particular circumstances. Fittings have been shown as typical configurations, however, in some cases product dimensions or installations may vary or be changed without notice. In all instances, the reader should contact Iplex Pipelines for clarification that the specific product is appropriate for their circumstances.



Iplex Pipelines NZ Ltd
67 Malden Street, Palmerston North.

Contact our Call Centre for further advice on
0800 800 262