



 **PLASSON**[®]
Series 1

TECHNICAL CATALOGUE

iPLEX
Pipelines

Plasson Series 1

The new range of innovative fittings created by Plasson, market leader in design and manufacture of reliable fittings for polyethylene pipe systems.

Plasson Series 1 fittings are designed to withstand 16 bar pressure rating.* Push-inserting the pipe up to the fitting stop inside the fitting bore, creates both the seal and the end load restraint grip on the pipe.

Compact and attractive design makes this fitting ideal for the plumbing market, where space is limited and appearance is crucial. Simplicity of assembly makes both the professional and occasional user's job easier while retaining the Plasson reliability.

* = 16 bar maximum continuous operating pressure, including pressure variation or surge (water hammer) at maximum 20°C operating temperature. Above 20°C pressure re-rating applies (Table 1).

Features and benefits

- Aesthetically designed product — gives a professional finish to the job
- Assembly tools not required — simple push fit assembly
- Compact size — can be assembled in confined spaces
- Instant seal and integrity of joint — captive seal and no nuts to tighten
- Full end load resistance performance — no need to restrain joints
- Correctly designed and installed Plasson Series 1 fittings will satisfy the 50 year service life requirement of the NZ Building Code, clause B2.3.1 (a).
- Tamper-resistant design — ensures system integrity
- Complies to AS/NZS 4129 Fittings for polyethylene (PE) pipes for pressure applications. License No. SMK02018
- Pipe support inserts are not required with Plasson Series 1 fittings.

Limitations on use

Plasson Series 1 fittings are designed for water reticulation applications only and are not suitable for use in the following applications:

- Compressed air or any industrial application, including glycol, oils or liquid fuels such as petrol, or diesel
- Transport of fuel gas, including LPG, CNG and NG.
- All fire rated applications
- The fitting is designed for use up to 40°C but a pressure de-rating factor must be applied above 20°C. (Table 1)
- Any subzero ('frozen') application where the fitting is not emptied of water before freezing occurs
- Any cyclic pumped application where the pressure repeatedly varies between zero and normal operating pressure
- Use with any plastic pipe material that is not PE, such as PE-X, PP, PPr or PVC
- In suction or vacuum applications where the pipe SDR class is insufficient to prevent vacuum collapse
- In any application that is unsuitable for PE pipe

Technical Specifications

Materials

Compression Fittings

Body: Polypropylene, high grade copolymer

Nut: High Grade Polypropylene

Split Ring and Grip Ring: Acetal (POM)

Liner: Acetal (POM)

Seal: Nitrile rubber (NBR)

Threaded Fittings

Body: Polypropylene, high grade copolymer

Reinforcing Ring: Stainless steel on all female offtakes from 1¼" up to 2"

Brass Threads: Dezincification resistant (DZR)

Operating Temperatures

Plasson Series 1 fittings are subject to pressure re-rating above 20°C

Table 1

Temp °C	De-rating Factor	Max. allowable Operating Pressure (bar)
20	1	16
25	0.9	14.4
30	0.8	12.8
40	0.65	10.4

Chemical Resistance

Plasson fittings are supplied, as standard, with polyacetal split and grip rings and NBR seals which are suitable for use with drinking water.

Operating Pressures and Quality Certificates

Plasson fittings sizes 20-63 are tested and approved according to AS/NZS 4129 PN16.

Threads

All threads conform to ISO - 7/1, BS 21, DIN 2999, NEN 3258, AS 1722 Part 1.

All external threads are tapered. All internal threads are parallel.

Note Before installation, ensure that the end of the pipe to be inserted into the fitting is free of scratches and other imperfections and that both the pipe and the fitting itself are free of sand, mud, stones, etc. If fittings are reused, ensure that the split ring and grip ring teeth are sharp and bite into the pipe, to avoid pullouts. If uncertain, replace the split ring and grip ring.

Note PTFE tape must be used in all threaded connections. For diameters 40mm and above, chamfering and lubrication of the pipe end will ease insertion (use silicone lubricant).

Component Parts

Figure 1 shows the principal component parts of a Plasson Series 1 fitting. (Note correct orientation and assembly order of grip ring (A) and split ring (B)).

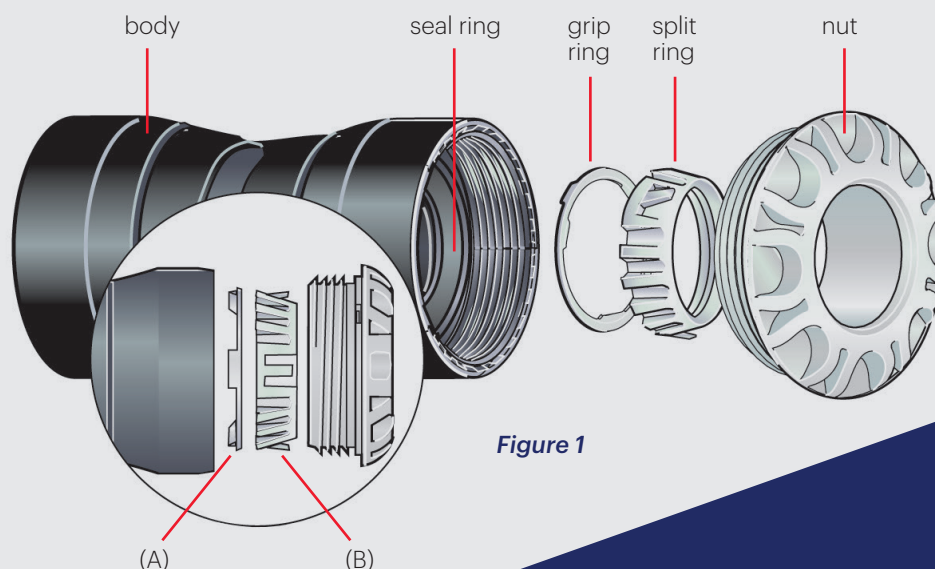
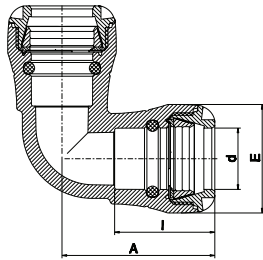

Figure 1



STANDARDSMARK
LICENCE NO. SMK02018
AS/NZS 4129

3501 - 90° Elbow



Legend

- UB** - Units Per Bag
- UC** - Units Per Carton
- W** - Weight In Grams

Iplex Code	Size d	E	A	I	UB	UC	W
3501.20	20	41	67	45	1	200	75
3501.25	25	47	73	48	1	190	96
3501.32	32	58	81	54	1	130	157
3501.40	40	70	106	70	1	65	291
3501.50	50	85	119	78	1	40	462
3501.63	63	103	141	90	1	25	799

3503 - Female Threaded Tee

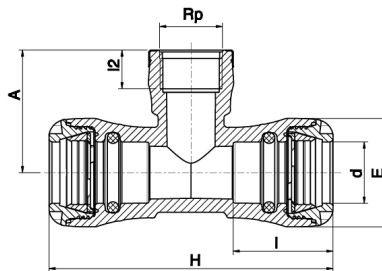

Iplex Code	Size d x G	E	H	A	I	l ₂	UB	UC	W
3503.20.15	20 x 1/2"	41	123	43	45	17	1	200	84
3503.25.15	25 x 1/2"	47	134	46	48	17	1	-	-
3503.25.20	32 x 3/4"	47	134	48	48	18	1	-	-
3503.32.25	40 x 1"	58	152	55	54	21	1	-	-

3504 - 90° Tee

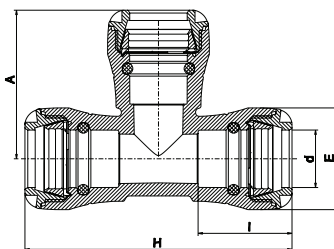

Iplex Code	Size d	E	H	A	I	UB	UC	W
3504.20	20	41	123	71	45	1	140	103
3504.25	25	47	134	78	48	1	130	137
3504.32	32	58	152	84	54	1	75	221
3504.40	40	70	192	108	70	1	45	429
3504.50	50	85	214	124	78	1	30	667
3504.63	63	103	262	147	90	1	14	1157

3505 - Reducing Tee

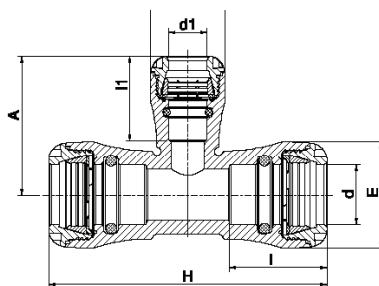

Iplex Code	Size d	H	A	E	E ₁	I	I ₂	UB	UC	W
3505.25.20	25 x 20 x 25	134	73	47	41	48	46	1	-	-
3505.32.20	32 x 20 x 32	152	75	58	41	54	46	1	-	-
3505.32.25	32 x 25 x 32	152	81	58	47	54	49	1	-	-

3506 - Female Threaded Adaptor

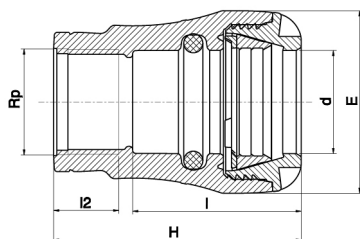

Iplex Code	Size d x G	E	H	I	I ₂	UB	UC	W
3506.20.15	20 x 1/2"	41	67	45	17	1	340	43
3506.25.20	25 x 3/4"	47	71	48	18	1	280	52
3506.32.25	32 x 1"	58	79	54	21	1	200	81
3506.40.32	40 x 1 1/4"	70	100	70	24	1	135	171
3506.50.40	50 x 1 1/2"	85	110	78	24	1	90	247
3506.63.50	63 x 2"	103	129	90	29	1	45	379

3507 - 90° Male Threaded Adaptor

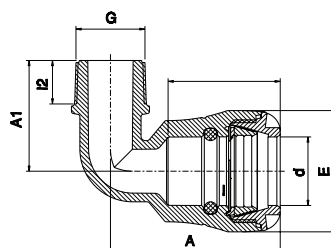

Iplex Code	Size d x G	E	A	I	A ₁	I ₂	UB	UC	W
3507.25.20	25 x 3/4"	47	74	48	45	17	1	250	64
3507.32.25	32 x 1"	58	81	53	53	19	1	180	92

3508 - 90° Female Threaded Adaptor

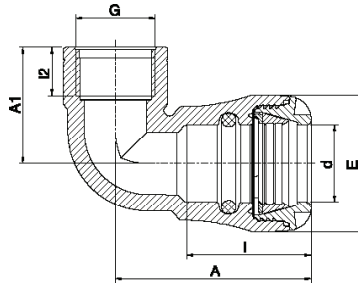

Iplex Code	Size d x G	E	I	A	A ₁	I ₂	UB	UC	W
3508.20.15	20 x 1/2"	41	45	67	39	17	1	240	51
3508.25.15	25 x 1/2"	47	48	74	40	17	1	250	63
3508.25.20	25 x 3/4"	47	48	74	43	18	1	250	70
3508.32.25	32 x 1"	58	54	83	49	21	1	160	111
3508.50.40	50 x 1 1/2"	58	54	83	45	18	1	180	95
3508.63.50	63 x 2"	58	54	83	49	21	1	160	111

3509 - Female Wingback Adaptor

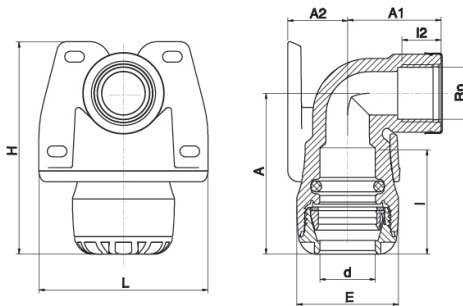

Iplex Code	Size d x G	E	I	I ₂	A	A ₁	A ₂	L	H	UB	UC	W
3509.20.15	20 x 1/2"	41	45	17	67	39	28	73	95	1	-	-

3510 - Coupling

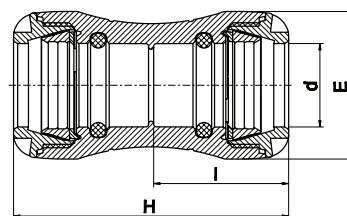

Iplex Code	Size d	E	H	I	UB	UC	W
3510.20	20	41	92	45	1	260	64
3510.25	25	47	98	48	1	200	80
3510.32	32	58	108	53	1	140	126
3510.40	40	70	142	70	1	90	234
3510.50	50	85	158	78	1	55	369
3510.63	63	103	183	90	1	30	620

3512 - Universal Coupling

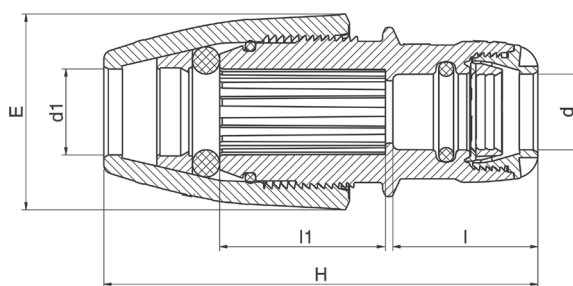

Iplex Code	Size d x d1	E	H	I	I ₁	UB	UC	W
3512.25.14-18	25 x 14-18	54	117-137	48	47	5	-	130g
3512.25.19-22	25 x 19-22	57	119-130	48	47	5	-	141g
3512.25.24-28	25 x 24-28	66	130-142	48	55	5	-	180g

Pipe		Universal Fitting Size Range (mm)		
Type	Standards	14-18 (mm)	19-22 (mm)	24-28 (mm)
		Nominal Size (DN)		
PE: Metric	AS/NZS 4130	-	20	25
PE: Imperial - LDPE	NZS 7601	15 (½")	-	20 (¾")
PE: Imperial - HDPE	NZS 7602	15 (½")	-	20 (¾")
Copper: NZ	NZS 3501	14.7	21	27.4
Copper: AS	AS3795	-	20 (¾")	25 (1")
PVC-U: AS/NZS	AS/NZS 4177	-	15	20
PB: AS/NZS	AS/NZS 2642.2	18	22	28
PE-X: AS/NZS	AS/NZS 4292	16	20	25
Galvanised Steel (Plain End)	AS 1074	10 (17.2mm OD)	15 (21.3mm OD)	20 (26.9mm OD)

Installation Instructions:

- Cut pipe square and deburr as necessary
- Select correct fitting according to the pipe outer diameter
- Slide the fitting (universal side) onto the pipe, to the pipe stop
- Whilst holding the fitting body with wrench, use another wrench to tighten the nut (do not overtighten)
- Assemble the metric PE pipe according to Series 1 fitting instructions

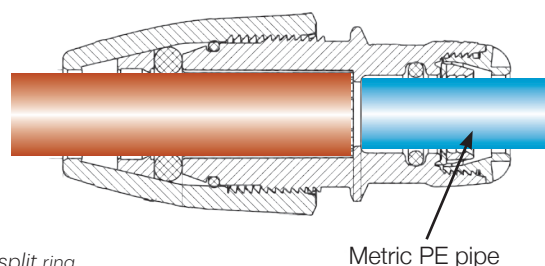

Note: If the fitting is re-used make sure metal teeth are present in the universal split ring.

3513 - Male Threaded Adaptor

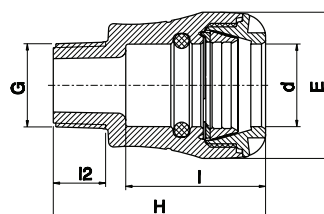

Iplex Code	Size d x G	E	H	I	I ₂	UB	UC	W
3513.20.15	20 x ½"	41	70	45	16	1	340	41
3513.25.20	25 x ¾"	47	76	48	17	1	280	52
3513.32.25	32 x 1"	58	84	55	19	1	220	86
3513.40.32	40 x 1¼"	70	106	73	21	1	135	149
3513.50.40	50 x 1½"	85	114	81	21	1	90	226
3513.63.50	63 x 2"	103	129	92	25	1	50	367

3523 - Reducing Coupler

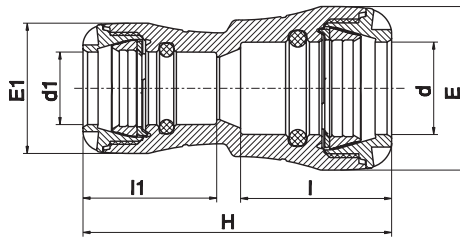

Iplex Code	Size d x d ₁	E	H	I	E ₁	I ₁	UB	UC	W
3523.25.20	25 x 20	47	100	48	41	45	1	200	75
3523.25.20	32 x 20	58	106	54	41	45	1	160	95
3523.25.25	32 x 25	58	110	54	47	48	1	180	109
3523.40.32	40 x 32	70	139	71	58	55	1	-	-
3523.50.25	50 x 25	85	151	79	47	51	1	-	-
3523.63.50	63 x 50	103	187	91	85	81	1	-	-

3530 - End Plug

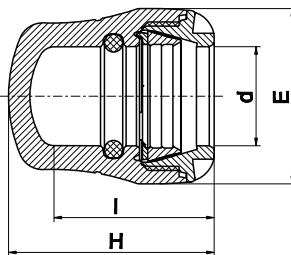

Iplex Code	Size d	E	H	I	UB	UC	W
3530.20	20	41	56	45	1	360	39
3530.25	25	47	60	48	1	300	50
3530.32	32	58	68	53	1	240	82
3530.40	40	70	90	71	1	150	146
3530.50	50	85	102	79	1	100	229
3530.63	63	103	117	91	1	55	379

Plasson Series 1 Wrench



Iplex Code	Size	UB	UC	W
Wrench.20.32	20 - 32	1	300	57
Wrench.40.63	40 - 63	1	100	285

Nut

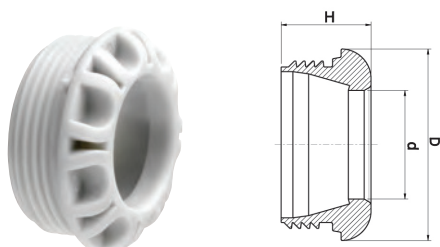

Size d	D	H	UB	UC	W
20	40	22	50	700	7
25	45	22	50	500	8
32	57	24	50	300	15
40	68	33	-	400	29
50	83	37	-	125	44
63	100	43	-	100	60

O-Ring

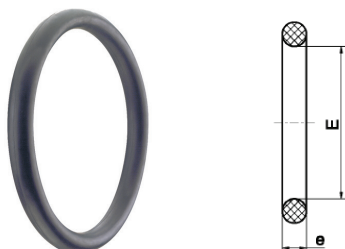

Iplex Code	Pipe Size	E	e	UB	UC	W
3560.20	20	19	4	50	32000	1
3560.25	25	24	5	50	16000	2
3560.32	32	31	6	50	10000	4

Shaped Seal

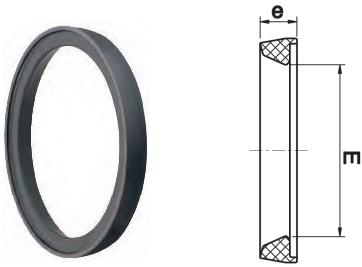

Iplex Code	Pipe Size	E	e	UB	UC	W
3560.40	40	38	10	50	4000	8
3560.50	50	48.6	10.5	50	2500	11
3560.63	63	60.6	11.2	50	2000	15

Split Ring

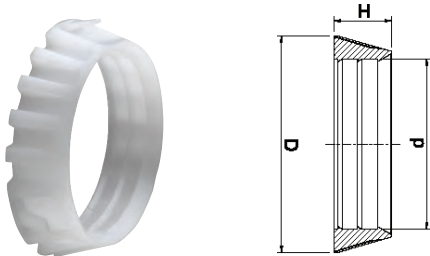

Iplex Code	Size d	D	H	UB	UC	W
3565.20	20	27	9	50	6000	2
3565.25	25	33	9	50	4500	3
3565.32	32	42	11	50	2000	4
3565.40	40	52	14	-	1600	14
3565.50	50	64	17	-	500	14
3565.63	63	81	21	-	500	27

Grip Ring

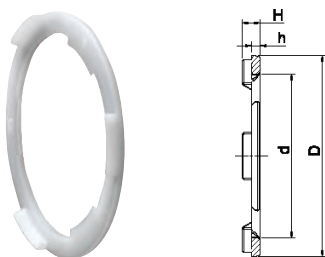

Size d	D	H	h	UB	UC	W
20	27	3.8	1.8	50	7000	1
25	33	3.7	1.7	50	5500	1
32	42	3.7	1.7	50	3000	1
40	52	4.0	2.2	50	2500	2
50	64	4.3	2.5	50	1000	3
63	80	4.8	3.0	50	1000	6

Installation Instructions

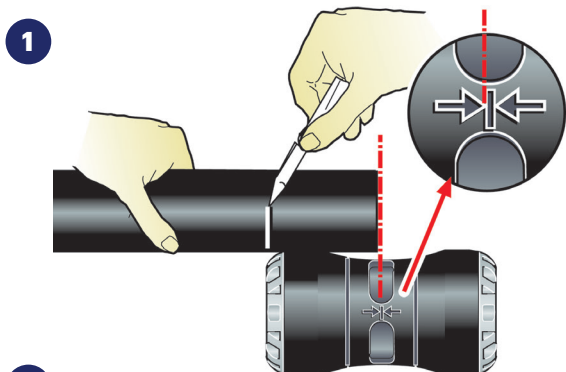

Step 1

- Clean pipe end
- Remove burs
- Mark insertion depth using guide on fitting
- Sizes 40mm and above – chamfering the pipe with a Plasson chamfer tool and using silicone lubricant will ease insertion

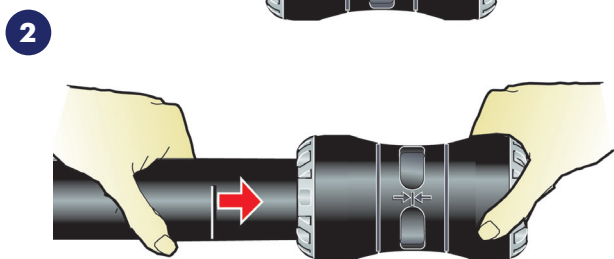

Step 2

- Insert pipe past O-ring until it meets the internal stop

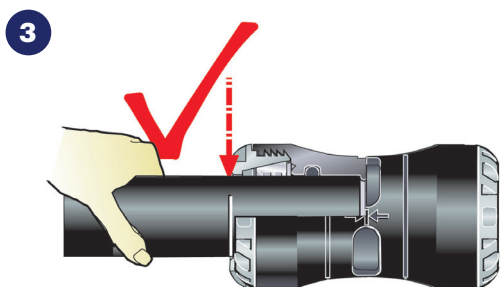

Step 3

- Check witness mark to ensure pipe is inserted correctly

Disassembly

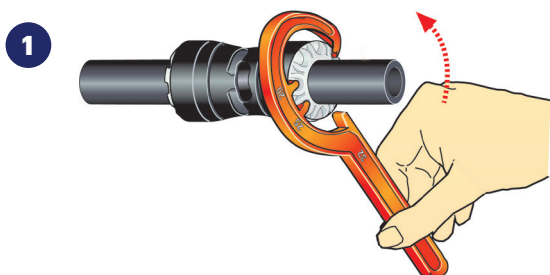

Step 1

- Use a Plasson Series 1 wrench to loosen the nut

Figure 1

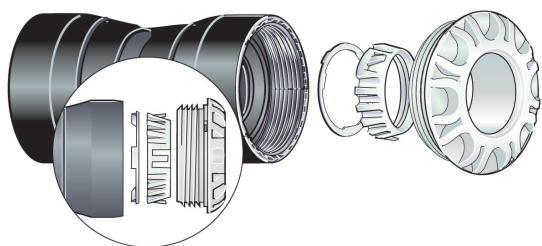

Step 2

- Remove the nut and slide pipe from fitting. When reassembling the fitting, ensure the components are placed into the fitting body in the correct orientation and assembly order. (Figure 1) Ensure any damaged/ blunted grip or split rings are replaced.

More products from Iplex Pipelines

NOVADRAIN

DRAIN WASTE & VENT SYSTEMS

SUPERSTORM™ & STORMFIT

PVC STORMWATER DUCT SYSTEM

NEXUS™ HI-WAY

ROAD DRAINAGE SYSTEM

NOVAKEY™ & BLUE BRUTE

uPVC PRESSURE SYSTEMS

WHITE & BLUE RHINO™

HIGH IMPACT mPVC PRESSURE PIPE

BLUELINE

MEDIUM DENSITY POLYETHYLENE PIPE

POLIPLEX

POLYETHYLENE PRESSURE PIPE

ALKATHENE™

LOW DENSITY POLYETHYLENE PIPE

NOVATUBE

HORTICULTURAL LATERAL TUBE

GREENLINE, REDLINE™, RURAL BLACK & BLACKLINE

MEDIUM DENSITY POLYETHYLENE PIPE

PLASSON

METRIC COMPRESSION FITTINGS

NEXUS™FLO, NEXUS™COIL, NOVAFLO™ & NOVACOIL

LAND DRAINAGE SYSTEMS

IPLEX EFFLUENT PIPE

MEDIUM DENSITY POLYETHYLENE PIPE

FARMTUFF™ & NEXUS™ CULVERT

CULVERT PIPE

RAINWATER SYSTEMS

SPOUTING & DOWNPIPE

POLIGAS™

POLYETHYLENE GAS SYSTEMS

iplex.co.nz

Iplex Pipelines NZ Limited
Call 0800 800 262 or Fax 0800 800 804

Auckland: Private Bag 92 114, 810 Great South Road, Penrose
Palmerston North: Private Bag 11019, 67 Malden Street
Christchurch: PO Box 16225, 22 Braeburn Drive, Sockburn

© 2018 IPLEX PIPELINES (NZ) LIMITED. NEXUS™, IPLEX™, RESTRAIN™, APOLLO™, NOVAFLO™, FARMTUFF™, NOVAKEY™, POLIGAS™, RHINO™, REDLINE™, SUPERSTORM™ are registered trademarks of IPLEX PIPELINES (NZ) LIMITED.